

CALDARA

TWO SECTIONS
VARIABLE HEIGHT
TREATMENT
COUCH FOR
PHYSICAL
THERAPY WIDTH
80 CM

INSTRUCTIONS FOR INSTALLATION,
USE AND MAINTENANCE

TF3XL0.80



INDEX:

- EC declaration of conformity	1
- Warranty certificate.	2
- General provisions	3
<i>Presentation of the manual</i>	
<i>Customer support service</i>	
<i>Conventions</i>	
- Safety	4
<i>General provisions</i>	
- Introduction	5
<i>Technical presentation</i>	
<i>Identification</i>	6
- General description	7
<i>Name of the parts</i>	
<i>Technical features</i>	8
<i>Materials used</i>	9
<i>Functional check</i>	10
<i>Disinfection</i>	
<i>Assembly</i>	11
- Installation	12
<i>Transport and handling</i>	
<i>Functional check</i>	
<i>Operation and use</i>	13
- Maintenance	14
<i>Periodic verification</i>	
<i>Provision and storage</i>	15
<i>Scrapping</i>	

EC declaration of conformity

Released by:

We, undersigned CALDARA SRL with headquarters in VIA TRIESTE 31B – 22036 ERBA (CO), acting as manufacturer of the medical device:

Class I Medical Device (Non sterile),

TF3XL0.80 - TWO SECTIONS TREATMENT COUCH VARIABLE HEIGHT FOR PHYSICAL THERAPY (WIDTH 80 CM)

Basic UDI-DI Code: 8055136920359TF3XL0.80LETT

declares, under its own responsibility, that this medical device:

- complies with essential requirements and dispositions of Regulation (EU) 2017/745 (MDR)
- common Specifications have not been used for the compliance of the above medical device
- complies with directive 2011/65/EU (and subsequent amendments and integrations) on the restriction of the use of certain hazardous substances in electrical and electronic equipment

Single Registration Number (SRN): registration in progress

Erba, 15th November 2021

Claudio Febbi
CEO at Caldara SRL

CALDARA s.r.l.

Warranty certificate

This certificate must be kept until the expiry date.

It must be presented every time a technical intervention is necessary, accompanied by the invoice, tax receipt, delivery note or any supporting document showing the name of the retailer and the date of purchase.

The user who is unable to produce these documents will lose all the warranty rights.

The warranty starts from the date of purchase shown on the invoice, receipt or delivery note and it is valid for 24 months for the moving and electric parts, 36 months for the product structure.

The guarantee refers to the replacement or free repair, within the established terms, of the components of the appliance which, at the discretion of the manufacturer, were found to be defective at the origin due to manufacturing defects. This warranty does not cover:

- _ transport faults (dents, scratches and similars);
- _ damage due to falls;
- _ damage caused by carelessness, negligence, inability to use the product, tampering and repairs carried out by unauthorized personnel;
- _ damages due to incorrect installation; if this is carried out by the user or by unauthorized personnel;
- _ damages caused by insufficiency or inadequacy of the electrical system or alterations deriving from environmental, climatic or other conditions, as well as damage caused by phenomena that do not depend on the normal operation of the appliance;
- _ technical interventions concerning the installation of the appliance and the connection to the power supply systems;
- _ home repairs for convenience checks or alleged defects. If requested, the user will have to pay to the person in charge a contribution previously estimated in advance with the intervention;
- _ ordinary maintenance;
- _ whatever may be normal decay for use.

However, product replacement is excluded.

The warranty intervention can be refused when the product has been modified or transformed in any way. The restoration of the appliance will be carried out within the time limits compatible with the organizational requirements, by authorized technicians, upon request by the user to the retailer or directly to the manufacturer.

In the event of home intervention, the user is required to pay the fixed fee for transfer fees.

If the appliance is repaired at the retailer or at the manufacturer, the transport costs and the relative risks will be charged to the user.

Warranty repairs do not result in an extension of the warranty itself.

Parts replaced under warranty remain property of the manufacturer.

No one is authorized to change the terms and conditions of the warranty or to issue other verbal or written ones. The manufacturer declines all responsibility for any damage, of any nature, that may directly or indirectly derive from persons, animals or things resulting from failure to comply with all the instructions contained in this manual concerning, in particular, the installation warnings, use and maintenance of the appliance or in any case improper use.

The manufacturer is also not responsible for any damage caused to people, animals or things due to breakdown or forced suspension of use of the equipment. The Court of Como has jurisdiction for any dispute.

General provisions

Presentation of the manual:

This manual is an integral part of the article.

Carefully read the warnings and instructions contained in this manual as they provide important information regarding SAFETY OF USE AND MAINTENANCE.

The descriptions and illustrations provided in this publication are not binding.

CALDARA S.R.L. reserves the right to make changes that it deems appropriate for the purpose of improvement, without committing to update this documentation.

The illustrations and images contained in this manual are intended as examples only and may differ from practical situations.

The manufacturer assumes no responsibility for direct or indirect damages, including loss of profits, or for any other damage of a commercial nature that may result from the use of the product that does not comply with what is described in this manual.

Customer assistance service:

Customer support and product support are important aspects of our corporate structure.

We are at your complete disposal for further information on the use and maintenance of this product. (info@caldarasrl.it)

Conventions:

The following graphic symbols have been used in this manual:



WARNING! It is placed before certain procedures. Failure to comply may damage the item.



WARNING! It is placed before certain procedures. Failure to comply may damage the operator, the patient or the article.

Safety

General provisions:



WARNING! Improper use and maintenance can cause damage to people and property.



WARNING! NOTICE FOR BLOOD DISEASES: to reduce the risk of exposure during the use of the chair, follow the maintenance instructions given in this manual, in addition to the provisions on the safety of personnel prepared by the head of the Emergency Medical Service.

Operators must carefully read this manual, follow the instructions it contains and become familiar with the correct procedures for using and maintaining the product.

Use and maintain the item only as prescribed in this manual and use only spare parts and assistance CALDARA S.R.L.

Keep this manual for consultation and in support of staff training.

Transfer it with the product in case of sale or transfer to new users.

Introduction

Technical presentation:

The bed is made of metal with remarkable performance characteristics that guarantee stability and strength. It comes with this innovative line that makes it very comfortable and easy to use for the operator. The cushion can be reclined by means of a gas spring that can be operated thanks to the ergonomic lever placed under the upper frame. The inclination of the headboard is + 50 ° in positive and -30 ° in negative. The two electric columns allow height adjustment without any front / rear translation using three different types of devices according to the needs. The devices that allow adjustment in addition to the pedal can be a push button panel or two perimetric bars (perimetric control) on the right and left, very comfortable; their length is equal to 1 m. The padded top in high-density rubber is covered in coated fabric (skai, imitation leather) fireproof class 1 IM washable with common detergents on the market. The structure is equipped with a roll holder. There are 4 adjustable feet. The electrical parts comply with the regulations in force in the hospital field.

Reference standards

The article was designed and built by CALDARA S.R.L. in compliance with the safety requisites foreseen by the directive (EU) 2017/745 (MDR) (class I) and s.m.i. (Directive 2007/47 / EEC) concerning medical devices.

Intended use

_Type of device: examination bed electrically height adjustable for examinations and therapeutic treatments in ambulatory and hospital environment. INDOOR USE.

_Environmental setting: hospitals and clinics in application environments 2 and 5. The room must be equipped with an electrical system in compliance with the regulations in force.

_ Staff assigned to use the product: specialized operators and doctors.

_ Supervision and responsibility: the bed must be used under the supervision of a doctor.

_Warning: the bed cannot be used in a potentially explosive atmosphere.

_Use limitations: the bed can only be used as described in this manual.

Environmental limits of use

The environmental conditions of use of the chair must follow these indications:

_Temperature: (0 to 50) C °

_Humidity: 10% -90% (not condensed)

Expected life

The bed has been designed to work without danger or risk to things or people, within the limits and conditions defined in this manual for a period of 10 years, after which replacement is recommended.

Correct functioning is guaranteed only by contacting the manufacturer or retailer whenever a fault occurs and in accordance with the instructions contained in this manual.

Manufacturer

The article described in this manual is produced by:

CALDARA

CALDARA S.R.L. Via Trieste 31/B 22036 Erba (CO) Italy PH +39 031 640896 info@caldarasrl.it
www.caldarasrl.it

Identification:



WARNING! it is forbidden to remove for any reason whatsoever label on the product.

The item can be identified by the label on the product following data is reported:

- _ Name and address of the manufacturer
- _ CE mark
- _ Article model
- _ Serial number

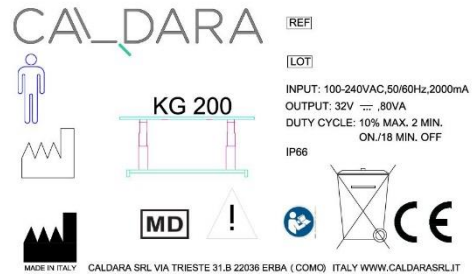

The electrical devices can be identified from the respective labels where the following data are reported:

Column actuator:

- _ Name and address of the manufacturer
- _ Article model
- _ Serial number
- _ Production date
- _ Maximum actuator load and IP protection degree
- _ Operation / consumption
- _ CE mark
- _ Production place
- _ Special waste



Control unit:

- _ Name and address of the manufacturer
- _ Article model
- _ Serial number
- _ Production date
- _ Functioning
- _ Max. Consumption
- _ IP protection degree
- _ CE mark
- _ Special waste



Applied part (control panel / perimeter / pedal board)

Class: Type B (Item Model / Serial Number)

Control panel



Perimeter

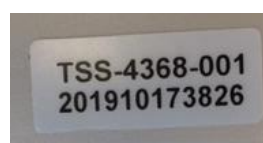

Pedal board



General description

Component names:

- 1_Base
- 2_Top floor
- 3_Headboard / backrest
- 4_Columns
- 5_Handle to adjust the headboard



Technical features:

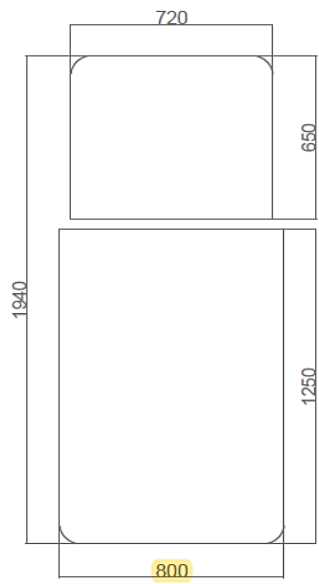
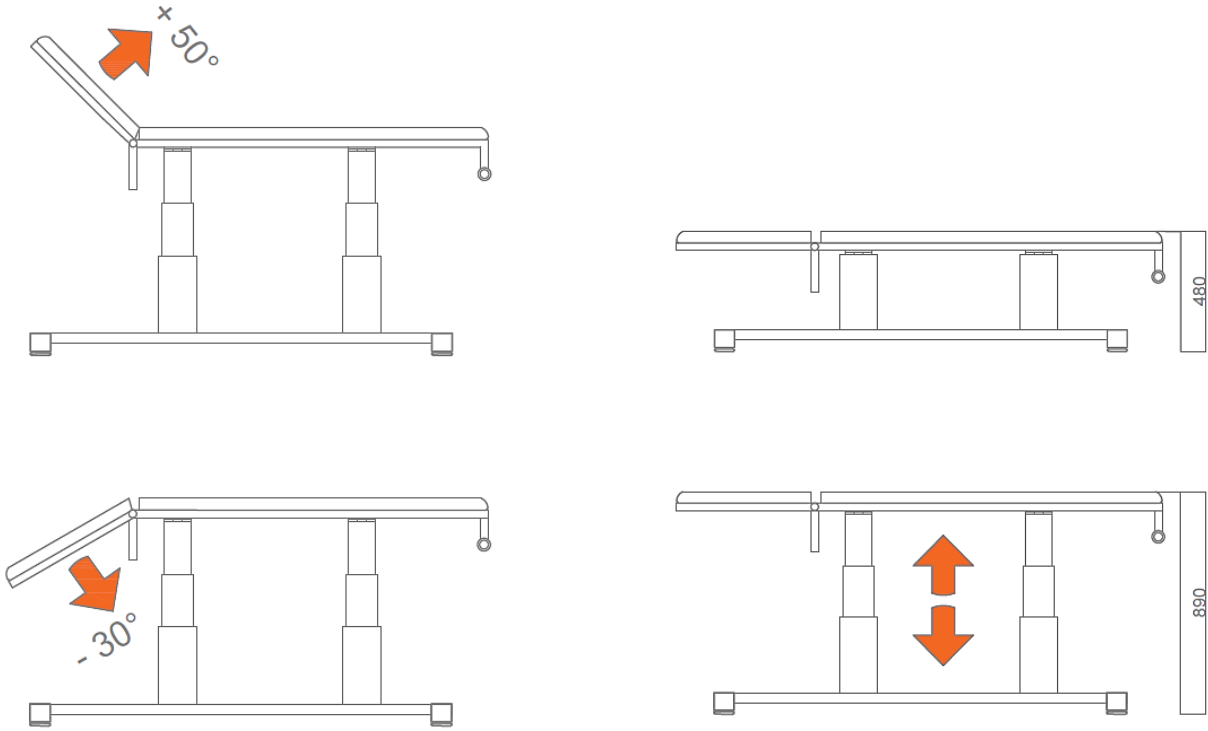

COD. TF3XL0.80

Materials used:

- _ Painted and galvanised steel for the metal structure;
- _ Top in wooden material, high density foam covered in fireproof washable class 1IM skai for the padded top;
- _ Column electric actuator with control unit and control devices for the adjustment of the upper surface;
- _ Gas spring for headboard adjustment;
- _ Galvanised steel bolts.

Functional verification:



WARNING! This check must be repeated periodically to verify the efficiency of the product.

Before using the product:
perform the "periodic check" provided in the Maintenance chapter.

Sanitising:



WARNING! Use neutral non-corrosive products available on the market. Sanitising agents can be corrosive.

Carefully read the instructions provided by the manufacturer of the sanitising agent for the specific application.

It is very important to follow the specifications concerning concentration, temperature and reaction times; changing one of these characteristics can cause damage to the product and alter its characteristics. Depending on how the chair is used, the user will establish useful sanitation intervals.

Assembly:

There are no parts to be assembled. Below there is an indicative drawing of how the product is assembled.

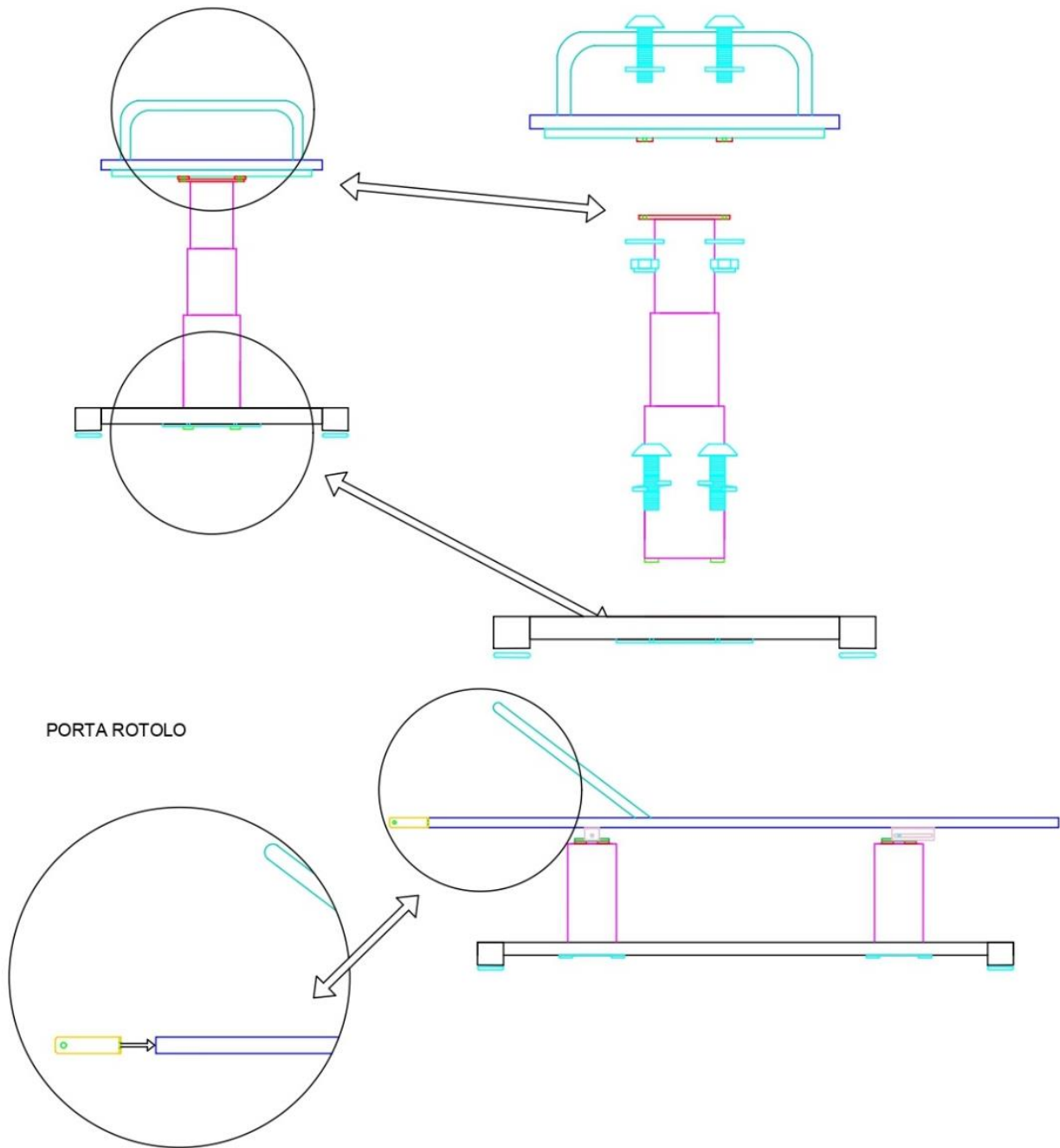

Installation

Transport and handling:



WARNING! The lifting and handling operations must be carried out by specialized personnel trained in this type of operation.

It is necessary to use means suitable for the transport and handling of this product such as manual or self-propelled forklift trucks, taking care to respect the precautions and rules for safety at work.

The product must be installed and used in environments suitable for its use, away from any atmospheric agents capable of compromising its correct use and functioning.

At the time of delivery or collection it is necessary to check that the contents are intact and that the equipment made for its use is also complete; only after carrying out these checks is it possible to eliminate the packaging in disposal and collection places of the recycled material.

If the item is damaged during transport, retain the packaging and contact the carrier within 48 hours of delivery.

Functional verification:



WARNING! This check must be repeated periodically to verify the efficiency of the product.

Before using the product:

perform the "periodic check" provided in the Maintenance chapter.

If the check fails, contact your dealer or CALDARA SRL and take the chair out of service;

in case of a positive result, use the product after observing the points described above.

Operation and use:

- 1_ Place the bed on a flat non-yielding floor.
- 2_ the space surrounding the bed must be free and allow for adjustment and maintenance operations.

 **WARNING!** always before seating the patient if the product is equipped with wheels, check that they are locked or raised from the ground.

 **WARNING!** the power cable must be adequately protected and must not hinder the operator.

 **WARNING!** When moving the bed, it is necessary to check that you have unplugged the power cord from the wall socket; re-evaluating the previous points.

- 3_ Seat the patient with the upper surface in a horizontal position and not in the tr / rtr position.
- 4_ Use one of the supplied controls to adjust the upper surface.

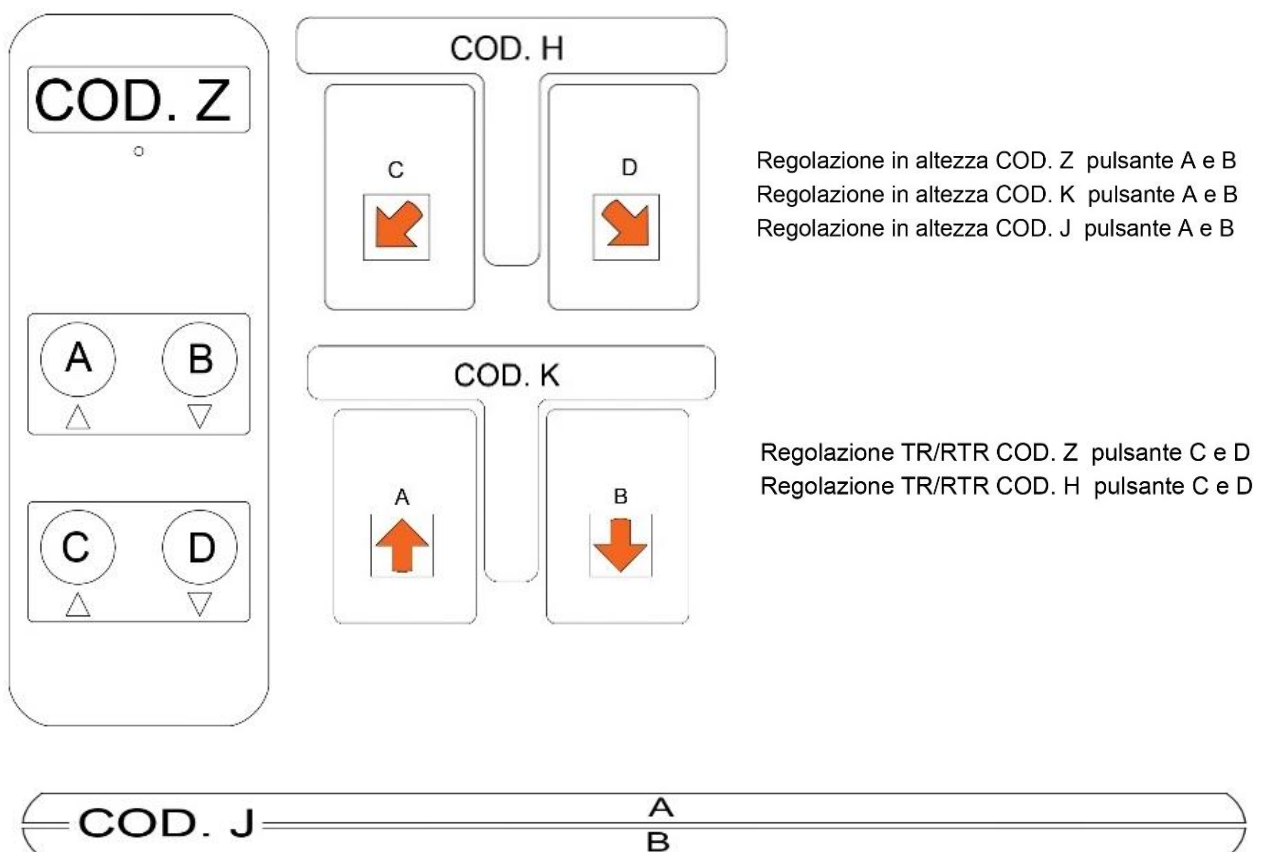

Maintenance

Periodic check:

It is necessary to inspect the product at least once a year.

An inspection means a visual search for any damage that could compromise the integrity and proper functioning of the article. You must check:

- _ integrity of the power cord and plugs;
- _ correct power cable connection;
- _ tightening of screws;
- _ correct functionality;
- _ correct insertion of any accessories.



WARNING! If damage is detected, immediately place the product out of service until it is repaired and put back into service.



WARNING! Any repairs and efficiency improvements are advised to be carried out by specialized technical personnel of the sales or assistance service.

Cleaning:

we recommend an accurate and periodic general cleaning of the product for a longer and better duration.



WARNING! It is recommended NOT to use: thinners, alcohol or petrol, aggressive and abrasive detergents.

Use water and neutral soap, rinse with a damp cloth and dry completely. This is an operation to be performed when necessary or at least every 15 days.

Shelving or storage:

In the event of provision or storage, the following instructions must be followed:

- _pack the product;
- _position it on a flat and safe surface;
- _must be in a dry place and away from the sun;
- _grease the moving parts which could be damaged in case of drying;
- _do not overlap any other item to the one set aside or stored.

Scrapping:

In case you decide not to use this product anymore, you need to:

- _make it inoperative;
- _make any parts that could cause dangers harmless.

In the event that this product is to be scrapped, it is necessary:

- _evaluate the classification of the asset according to the degree of disposal;
- _separate the various components and place them in the appropriate collection centres;
- _if considered special waste, dispose of according to the laws in force.



web link to www.caldarasrl.it

